



Automatic Generation Control in Four Area Interconnected Power System of Thermal Generating Unit through Evolutionary Technique

Ashish Dhamanda¹, Arunesh Dutt², and A. K. Bhardwaj³

¹Department of Electrical Engineering, FET, GKV, Haridwar, U.K, India

²Department of Electrical and Electronics Engineering, SGIET, SHIATS, Allahabad, India

³Department of Electrical Engineering, SSET, SHIATS, Allahabad, U.P, India

dhamanda_ashish@yahoo.co.in, aru_121@rediffmail.com, dr.akbhardwaj65@rediff.com

Abstract: This paper deals to find the dynamic response of load frequency and corresponding tie-line power of an automatic generation control (AGC) in four area interconnected thermal power system by using two different technique (Controller); One is Intelligent (Fuzzy Logic Controller) technique and second is Evolutionary (GA for tuning of PID Controller) Technique. In this paper evolutionary technique are proposed for improving the performance of load frequency and tie-line power and their dynamic responses are compared with the intelligent controller's responses. The results indicate that the proposed controller exhibit better performance and satisfy the automatic generation control requirements with a reasonable dynamic response. The performances of the controllers are simulated using MATLAB/SIMULINK software.

Keywords: Automatic Generation Control (AGC), Proportional Plus Integral Plus Derivative (PID), Genetic Algorithm (GA), Fuzzy Logic.

1. Introduction

Automatic Generation Control (AGC) is a very important issue in power system operation and control for supplying sufficient and reliable electric power with good quality. AGC with load following is treated as an ancillary service that is essential for maintaining the electrical system reliability at an adequate level [12] recent years, major changes have been introduced into the structure of electric power utilities all around the world. The successful operation in power system requires the matching of total generation with total load demand and associated system losses. As the demand deviates from its normal value with an unpredictable small amount, the operating point of power system changes, and hence, system may experience deviations in nominal system frequency which may yield undesirable effects. So the objective of AGC in interconnected thermal generating unit is to maintain the system frequency and tie line power at nominal value (60 Hz) [4], [5], [17], [18].

A control strategy is needed to maintain constancy of frequency and tie-line power and also achieves zero steady state error. The fuzzy controller employed to solve AGC problem and these controller gives the good response, reduces the oscillation & steady state error but the GA after tuning of PID controller gives the better result over the conventional and intelligent controller.

A literature survey shows that the load frequency control (LFC) of power systems has been investigated by many researchers over the past decades [13]. Most of the earlier works in the area of AGC pertain to thermal systems with non-reheat and reheat type turbines for single and two area with different controller but relatively lesser attention has been devoted to the comparison of fuzzy and GA controllers. Four area thermal power system incorporating reheat type turbine and linearized models of governors, non-reheat turbines and reheat turbines are taken for simulation of the system.

2. Automatic Generation Control

The role of AGC in interconnected power system is to maintain the system frequency and tie-line power at nominal value after some kind of perturbation arises in the system.

To maintain the electrical power system in normal operating state, the generated power should match with power demand plus associated losses. However, in practical power system, the load is continuously changing with respect to time. Therefore, the power balance equilibrium cannot be satisfied in abnormal state. In primary control action also called without controller, when the power system is said to be at stable state, primary control action takes place within an area to suppress frequency oscillations. On the other hand, when the load fluctuations are more, primary control action are not adequate to control.

To overcome the problem of primary control action, the secondary control action also called with controller, need to apply, these controllers are set for a particular operating condition and they take care of small changes condition and they take care of small changes in load demand without exceeding the prescribed limits of frequency. These control action comprises of different controller like intelligent and evolutionary technique [2], [3], [8], [9], [11], [16].

The model of without controller and with controller is shown below in figure 1.

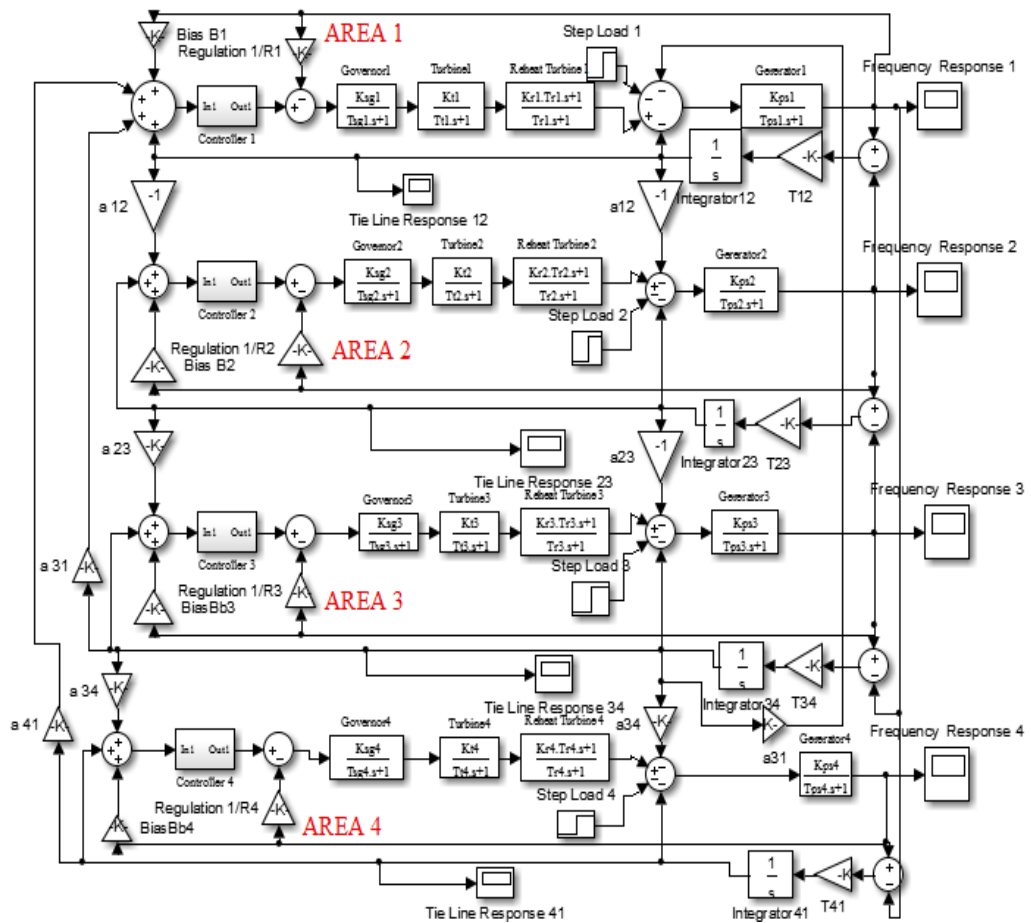

Figure 1. Four Area AGC Model of Reheat Thermal Generating System

Let us consider the problem of controlling the power output of the generators of a closely knit electric area so as to maintain the scheduled frequency. All the generators in such an area constitute a coherent group so that all the generators speed up and slow down together maintaining their relative power angles. Such an area is defined as a control area. To understand the AGC problem of frequency control, let us consider a single turbo-generator system supplying an isolated load. [2]

For a sudden step change of load demand,

$$\Delta P_G(s) = \frac{\Delta P_D}{s}$$

To simplify the frequency-domain analyses, transfer functions are used to model each component of the area. [4], [17], [18]

$$\text{Transfer function of governor is } \frac{K_{sg}}{T_{sg}s+1} \quad (1)$$

$$\text{Transfer function of turbine is } \frac{K_t}{T_t s+1} \quad (2)$$

$$\text{Transfer function of Reheat turbine is } \frac{K_r T_r s + 1}{T_r s + 1} \quad (3)$$

$$\text{Transfer function of generator is } \frac{K_{ps}}{T_{ps}s+1} \quad (4)$$

Dynamic response of automatic frequency control loop is

$$\Delta F(s) = - \frac{\frac{K_{ps}}{1+T_{ps}s}}{1+\frac{K_{ps}}{R(1+T_{ps}s)}} \frac{\Delta P_D}{s} \quad (5)$$

the change in frequency is given by

$$\begin{aligned} \Delta F(s)|_{\Delta PC(s)=0} &= - \left[\frac{\frac{K_{ps}}{1+sT_{ps}}}{1+\frac{K_{ps}}{1+sT_{ps}} \times \frac{1}{R}} \right] \times \frac{\Delta P_D}{s} \\ &= - \left[\frac{K_{ps}}{(1+sT_{ps}) + \frac{K_{ps}}{R}} \right] \times \frac{\Delta P_D}{s} \\ &= - \left[\frac{K_{ps}}{sT_{ps} + \frac{K_{ps}+R}{R}} \right] \times \frac{\Delta P_D}{s} \\ &= - \left[\frac{\frac{K_{ps}}{T_{ps}}}{s + \frac{K_{ps}+R}{RT_{ps}}} \right] \times \frac{\Delta P_D}{s} \\ &= - \frac{K_{ps} \times \Delta P_D}{T_{ps}} \left[\frac{1}{s + \frac{K_{ps}+R}{RT_{ps}}} \right] \\ \Delta F(s)|_{\Delta PC(s)=0} &= - \frac{K_{ps} \times \Delta P_D}{T_{ps}} \times \frac{RT_{ps}}{K_{ps}+R} \left[\frac{1}{s} - \frac{1}{(s + \frac{K_{ps}+R}{RT_{ps}})} \right] \\ \Delta f(t) &= L^{-1} \Delta F(s) \\ \Delta f(t) &= - \frac{RK_{ps}}{K_{ps}+R} \left[1 - e^{-\left[\frac{t}{T_{ps}} \frac{RT_{ps}}{K_{ps}+R} \right]} \right] \Delta P_D \end{aligned} \quad (5a)$$

This is equation for dynamic state, and help to determine the dynamic response of the system.

Equation [5] can be written as, [2], [3]. [11]

$$\Delta F(s) = -\Delta P_D \frac{RK_{ps}}{R+K_{ps}} \left(\frac{1}{s} - \frac{1}{s + \frac{R+K_{ps}}{RT_{ps}}} \right) \quad (6)$$

Therefore equation (6) can be simplified as:

$$\Delta f = - \left[\frac{K_{ps}}{1+\frac{K_{ps}}{R}} \right] \times \Delta P_D$$

Also we know from the dynamics of the generator load model, $K_{ps} = \frac{1}{B}$.

Where $B = \frac{\partial P_D}{\partial f}$ MW/Hz.

$$= \frac{\partial P_D}{\partial f} \text{ in p.u.MW/unit change in frequency.}$$

$$\Delta f = - \left[\frac{\frac{1}{B}}{1 + \frac{1}{BR}} \right] \times \Delta P_D$$

$$\Delta f = - \left[\frac{1}{B + \frac{1}{R}} \right] \times \Delta P_D = - \frac{1}{\beta} \cdot \Delta P_D \quad (7)$$

Where the factor $\beta = \left[B + \frac{1}{R} \right]$ and is known as the area frequency response characteristic (AFRC) or area frequency regulation characteristic.

Equation (7) gives the steady state response of frequency to the changes in load demand. The speed regulation is usually so adjusted that changes in frequency are small (of the order of 5%) from no load to full load.

Power system parameter B is generally much less than (i.e., $B \ll \frac{1}{R}$). So that B can be neglected in equation (7), which result in

$$\Delta f = - R (\Delta P_D) \quad (7a)$$

The droop of the frequency curve is thus mainly determined by the speed governor regulation (R).

The increase in load demand (ΔP_D) is met under steady state conditions partly by the increased generation (ΔP_G) due to the opening of the steam valve and partly by the decreased load demand due to droop in frequency.

The increase in generation is expressed as

$$\Delta P_G = - \frac{1}{R} \Delta f$$

Substituting Δf from equation (7), we get

$$\Delta P_G = - \frac{1}{R} \left[- \left[\frac{1}{B + \frac{1}{R}} \right] \Delta P_D \right] = \left[\frac{1}{R} \times \frac{R}{BR + 1} \right] \Delta P_D$$

$$= \left[\frac{1}{BR + 1} \right] \Delta P_D \quad (7b)$$

And a decrease in the system load is expressed as

$$B \Delta f = B \left[- \left[\frac{1}{B + \frac{1}{R}} \right] \Delta P_D \right] = B \left[\frac{1}{BR + 1} \right] \Delta P_D = \left[\frac{BR}{BR + 1} \right] \Delta P_D \quad (7c)$$

From equation (7b) and (7c), it is observed that contribution of the decrease in the system load is much less than the increase in generation.

Power flow out of control area-1 can be expressed as

$$P_{TL1} = \frac{|E_1| |E_2|}{X_{TL}} \sin (\delta_1 - \delta_2) \quad (8)$$

Where $|E_1|$ and $|E_2|$ are voltage magnitude of area 1 and area 2, respectively, δ_1 and δ_2 are the power angles of equivalent machines of their respective area, and X_{TL} is the tie line reactance.

If there is change in load demands of two areas, there will be incremental changes in power angles ($\Delta\delta_1$ and $\Delta\delta_2$). Then, the change in the tie line power is

$$P_{TL1} + \Delta P_{TL1} = \frac{|E_1| |E_2|}{X_{TL}} \sin [(\delta_1 - \delta_2) + \sin (\Delta\delta_1 - \Delta\delta_2)]$$

After solving the above equation we get,

$$P_{TL1} + \Delta P_{TL1} = \frac{|E_1||E_2|}{X_{TL}} \sin(\delta_1 - \delta_2) + \frac{|E_1||E_2|}{X_{TL}} [\cos(\delta_1 - \delta_2) (\Delta\delta_1 - \Delta\delta_2)]$$

Therefore, change in incremental tie-line power can be expressed as

$$\begin{aligned} \Delta P_{TL1} &= \frac{|E_1||E_2|}{X_{TL}} [\cos(\delta_1 - \delta_2) (\Delta\delta_1 - \Delta\delta_2)] \text{ MW} \\ \Delta P_{TL1} &= T_{12} (\delta_1 - \delta_2) \end{aligned} \quad (9)$$

$$\text{Where } T_{12} = \frac{|E_1||E_2|}{X_{TL}P_1} \cos(\delta_1 - \delta_2) \quad \text{MW/rad} \quad (10)$$

T_{12} is known as the synchronizing coefficient or the stiffness coefficient of the tie-line. Equation (10) can be written as

$$T_{12} = \frac{P_{max12}}{P_1} \cos(\delta_1 - \delta_2) \quad (11)$$

Where $P_{max12} = \frac{|E_1||E_2|}{X_{TL}P_2}$ = Static transmission capacity of the tie line.

Consider the change in frequency as

$$\begin{aligned} \Delta\omega &= \frac{d}{dt} (\Delta\delta) \\ 2\pi\Delta f &= \frac{d}{dt} (\Delta\delta) \\ \Delta f &= \frac{1}{2\pi} \times \frac{d}{dt} (\Delta\delta) \text{ Hz} \end{aligned}$$

In other words,

$$\begin{aligned} \frac{d}{dt} (\Delta\delta) &= 2\pi\Delta f \\ \int \frac{d}{dt} (\Delta\delta) &= \int 2\pi\Delta f \\ \Delta\delta &= 2\pi \int \Delta f \text{ dt radians} \end{aligned}$$

Hence, the changes in power angles for area 1 and area 2 are

$$\begin{aligned} \Delta\delta_1 &= 2\pi \int \Delta f_1 \text{ dt} \\ \text{And } \Delta\delta_2 &= 2\pi \int \Delta f_2 \text{ dt} \end{aligned}$$

Since the incremental power angles are related in terms of integrals of incremental frequency, equation (9) can be modified as

$$\begin{aligned} \Delta P_{TL1} &= 2\pi T_{12} (\int \Delta f_1 \text{ dt} - \int \Delta f_2 \text{ dt}) \\ \Delta f_1 \text{ and } \Delta f_2 &\text{ are the incremental frequency changes of area-1 and area-2, respectively.} \end{aligned} \quad (12)$$

Similarly, the incremental tie-line power out of area-2 is

$$\Delta P_{TL2} = 2\pi T_{21} (\int \Delta f_2 \text{ dt} - \int \Delta f_1 \text{ dt}) \quad (13)$$

$$\text{Where } T_{21} = \frac{|E_1||E_2|}{X_{TL}P_2} \cos(\delta_2 - \delta_1) \quad \text{MW/rad} \quad (14)$$

Dividing equation (14) by equation (11), we get

$$\begin{aligned} \frac{T_{21}}{T_{12}} &= \frac{T_{21}}{T_{12}} = a_{12} \\ \text{Therefore, } T_{21} &= a_{12} T_{12} \\ \text{And hence } \Delta P_{TL2} &= a_{12} \Delta P_{TL1} \end{aligned} \quad (15)$$

Surplus power in p.u. for single area case is

$$\Delta P_G - \Delta P_D = \frac{2H}{f_0} \frac{d}{dt} (\Delta f) + B \Delta f \quad (16)$$

For a two area case, the surplus power can be expressed in p.u. as

$$\Delta P_{G1} - \Delta P_{D1} = \frac{2H_1}{f_0} \frac{d}{dt} (\Delta f_1) + B_1 \Delta f_1 + \Delta P_{TL1} \quad (17)$$

Taking Laplace transform on both sides of equation (18)

$$\Delta P_{G1}(s) - \Delta P_{D1}(s) = \frac{2H_1}{f_0} s \frac{d}{dt} (\Delta F_1(s)) + B_1 \Delta F_1(s) + \Delta P_{TL1}(s)$$

Rearranging the above equation as follows, we get

$$\begin{aligned} \Delta P_{G1}(s) - \Delta P_{D1}(s) &= \Delta F_1(s) \left(\frac{2H_1}{f_0} s + B_1 \right) + \Delta P_{TL1}(s) \\ \Delta F_1(s) &= [\Delta P_{G1}(s) - \Delta P_{D1}(s) - \Delta P_{TL1}(s)] \left[\frac{\frac{1}{B_1}}{1 + \left[\frac{2H_1}{B_1 f_0} \right] s} \right] \\ \Delta F_1(s) &= [\Delta P_{G1}(s) - \Delta P_{D1}(s) - \Delta P_{TL1}(s)] \frac{K_{ps1}}{1 + T_{ps1}s} \\ \text{Where } K_{ps1} &= \frac{1}{B_1} \quad \text{and} \quad T_{ps1} = \frac{2H_1}{B_1 f_0} \end{aligned} \quad (18)$$

By comparing equation (18) with single area equation (16), the only additional terms is the appearance of signal $\Delta P_{TL1}(s)$. Taking Laplace transform on both sides of equation (12), we get

For Control area-1

$$\Delta P_{TL1}(s) = 2\pi T_{12} \left[\frac{\Delta F_1(s)}{s} - \frac{\Delta F_2(s)}{s} \right]$$

Or this equation can be written as

$$\Delta P_{TL1}(s) = \frac{2\pi T_{12}}{s} [\Delta F_1(s) - \Delta F_2(s)] \quad (19)$$

For Control area-2

$$\begin{aligned} \Delta P_{TL2}(s) &= 2\pi T_{21} \left[\frac{\Delta F_2(s)}{s} - \frac{\Delta F_1(s)}{s} \right] \\ &= -2\pi a_{12} T_{12} \left[\frac{\Delta F_1(s)}{s} - \frac{\Delta F_2(s)}{s} \right] \\ \Delta P_{TL2}(s) &= \frac{-2\pi a_{12} T_{12}}{s} [\Delta F_1(s) - \Delta F_2(s)] \end{aligned} \quad (20)$$

In single area power system, Area Control Error (ACE) is the change in frequency. In a two power system, ACE is the linear combination of the change in frequency and change in tie-line power. Thus, for control area-1 we have

$$ACE_1 = \Delta P_{TL1} + b_1 \Delta f_1 \quad (21)$$

Where $b_1 = \text{constant} = \text{area frequency bias}$. Taking Laplace transform on both sides of equation (21), we get

$$ACE_1(s) = \Delta P_{TL1}(s) + b_1 \Delta F_1(s) \quad (22)$$

Similarly, for control area-2, we have

$$ACE_2(s) = \Delta P_{TL2}(s) + b_2 \Delta F_2(s) \quad (23)$$

Equation (22) and (23) indicate that a control signal made of tie-line flow deviation added to frequency deviation weighted by a bias factor would accomplish the desired objectives. This control signal is known as area control error (ACE).

3. Control Strategy

Controller determines the value of controlled variable, compare the actual value to the desired value (reference input), determines the deviation and produces a control signal that will reduce the deviation to zero or to a smallest possible value. In automatic generation control of

thermal generating unit need to control or maintain the frequency constancy, reduced oscillation and zero steady state error, so following types of controller are used, [10]

A. PID Technique

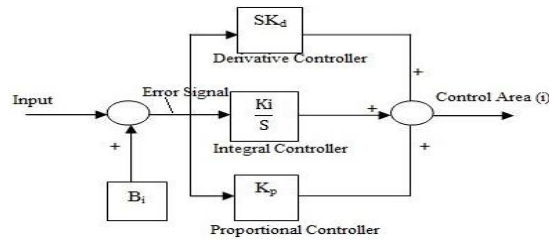

Figure. 2 Proportional Plus Integral Plus Derivative Control Scheme Model

This is a combination of proportional, integral and derivative controller so called three action controller. This controller are using from many year back for controlling such action with maintaining their performance.

$$\text{Control Area Input} = K_p \text{ Error Signal} + K_p K_i \int (\text{Error Signal} + K_p K_d \frac{d \text{Error Signal}}{dt}) \quad (24)$$

B. Intelligent (Fuzzy Logic) Technique

Fuzzy logic establishes the rules of a nonlinear mapping. There has been extensive use of fuzzy logic in control applications. One of its main advantages is that controller parameters can be changed very quickly depending on the system dynamics because no parameter estimation is required in designing controller for nonlinear systems. Fuzzy logic controller is shown below [6],

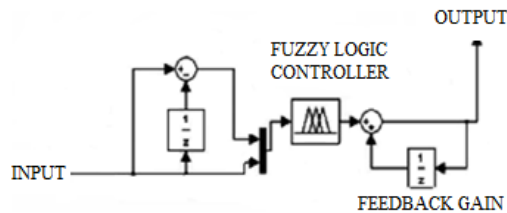

Figure 3. Fuzzy Logic Control Scheme Model

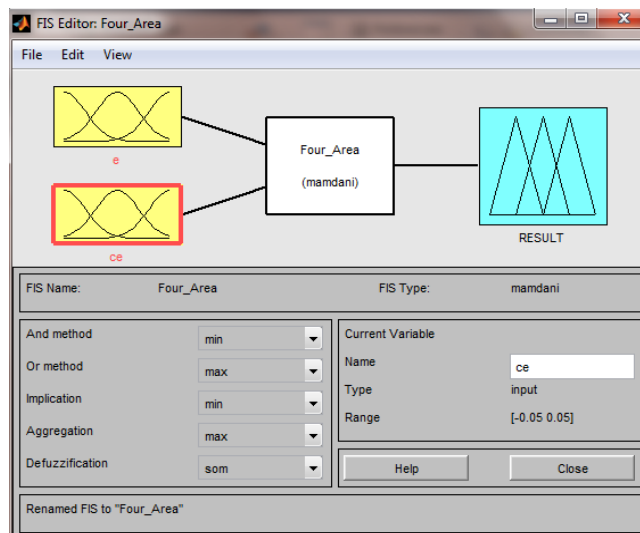

Figure 4. Fuzzy Inference System Editor

The inputs of the proposed fuzzy controller are e , and rate of change in ce . The appropriate membership function and fuzzy rule base is shown in below, where 7 membership function, NB, NM, NS, Z, PS, PM, and PB represent negative big, negative medium, negative small, zero, positive small, positive medium, and positive big, respectively make 49 (7×7) rule [7].

Table 1. Fuzzy Inference Rule

		Error (e)						
		NB	NM	NS	ZO	PS	PM	PB
Change in Error (ce)	NB	PB	PB	PB	PB	PM	PM	PS
	NM	PB	PM	PM	PM	PS	PS	PS
	NS	PM	PM	PS	PS	PS	PS	ZO
	ZO	NS	NS	NS	ZO	PS	PS	PS
	PS	ZO	NS	NS	NS	NS	NM	NM
	PM	NS	NS	NM	NM	NM	NB	NB
	PB	NS	NM	NB	NB	NB	NB	NB

C. Evolutionary (GA Controller) Technique

The genetic algorithm is a robust optimization technique based on natural selection. A possible solution to a specific problem is seen as an individual. A collection of a number of individuals is called a population. The current population reproduces new individuals that are called the new generation. The new individuals of the new generation are supposed to have better performance than the individuals of the previous generation. GA have been successfully implemented in the area of industrial electronics, system identification, control robotics, pattern recognition, planning and scheduling, flow chart for tuning of PID controller using genetic algorithm is shown below in Figure. 5, [14], [15].

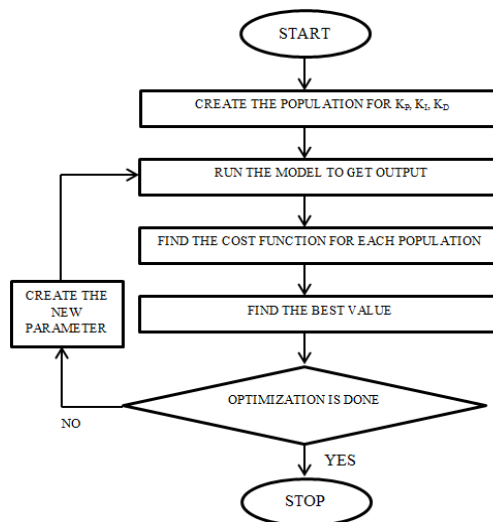

Figure 5. Flow chart for tuning of PID using genetic algorithm (GA)

Table 2. GA Parameters

	Fitness Function	Variables	Population Size	Selection	Mutation	Cross Over	Bound Limit
Four Area	@fun_pid	12	20	Stochastic	Constant Dependent	Scattered	[0-5]

The above table 2 show the GA parameters used in this paper for solving of AGCs problem of four areas. The table 3 for different valus of P, I, D is shown bellows:

Table 3. PID Value for tuning using GA controller

PID	P ₁	I ₁	D ₁	P ₂	I ₂	D ₂	P ₃	I ₃	D ₃	P ₄	I ₄	D ₄
Value	-4.6429	-4.9075	-2.3772	-4.6757	-0.5139	-2.2219	-2.1344	-0.9539	-2.0876	-0.1238	-1.1348	-0.2012

This table gives the values of P, I, D, which are 12 variables used for tuning by using GA controller

4. Results and Discussion

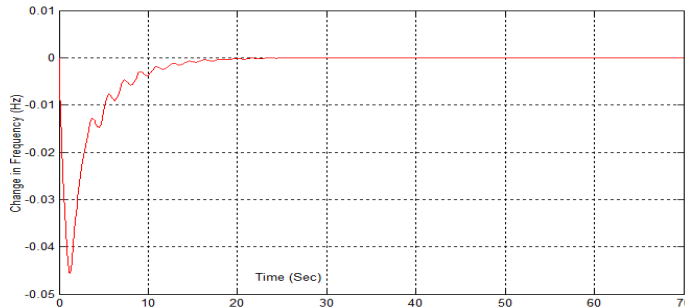

Figure 6. Frequency Response of Area 1 with Fuzzy Controller

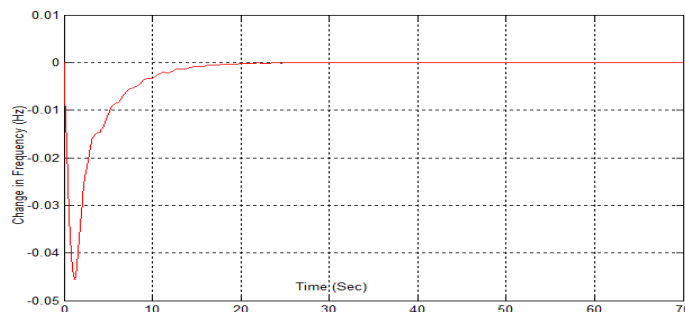

Figure 7. Frequency Response of Area 2 with Fuzzy Controller

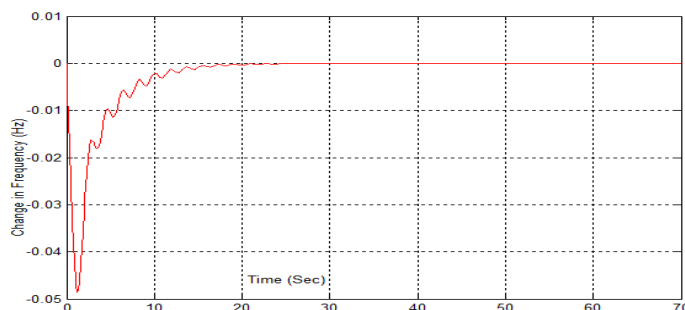

Figure 8. Frequency Response of Area 3 with Fuzzy Controller

All the results are carried out by using MATLAB/Simulink to investigate the performance of four areas reheat thermal system. The power system parameters are given in appendix. The step load disturbance of 0.01 p.u. was applied in four areas for all the cases and deviations in frequency and corresponding tie-line power were investigated. The AGC performance through fuzzy logic technique is compared with GA (Using tuning of PID controller) technique. The change in frequency and corresponding tie-line deviation under the load disturbances of 0.01 p.u. in four areas are shown in figure 6 to figure 21. Comparative value of settling time shown

in table 2, it is observed that the evolutionary (GA for tuning of PID Controller) technique controller improve the dynamic performance of the system as compared to intelligent (Fuzzy Logic Controller) techniques.

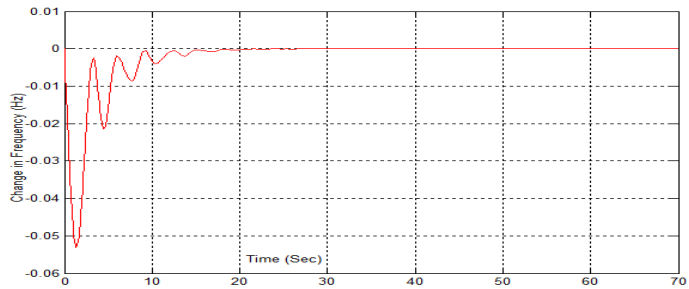

Figure 9. Frequency Response of Area 4 with Fuzzy Controller

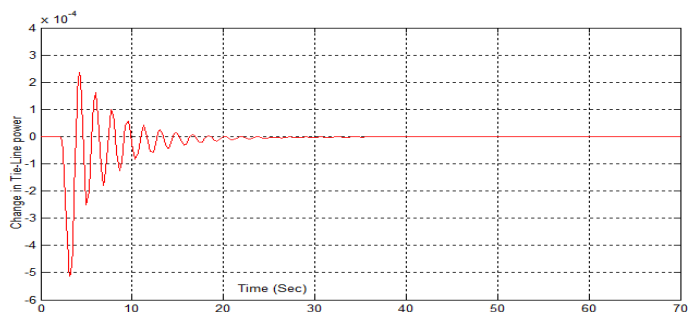

Figure 10. Tie-Line Power Response of Area 1 with Fuzzy Controller

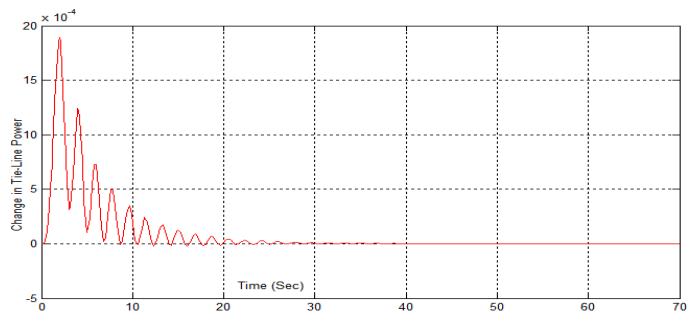

Figure 11. Tie-Line Power Response of Area 2 with Fuzzy Controller

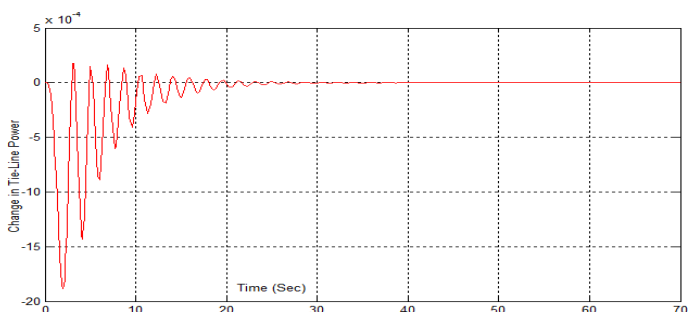

Figure 12. Tie-Line Power Response of Area 3 with Fuzzy Controller

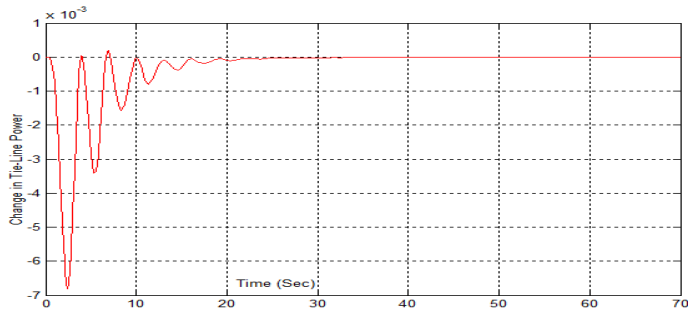

Figure. 13 Tie-Line Power Response of Area 4 with Fuzzy Controller

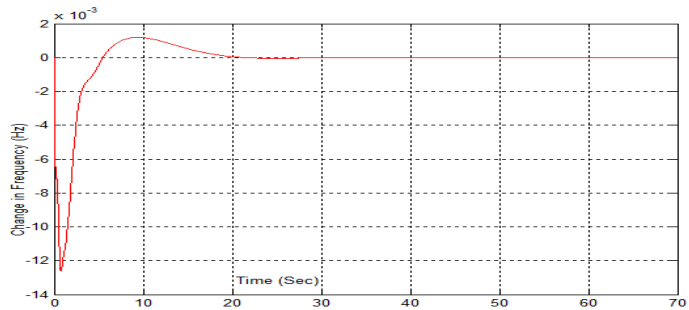

Figure 14. Frequency Response of Area 1 with GA Controller

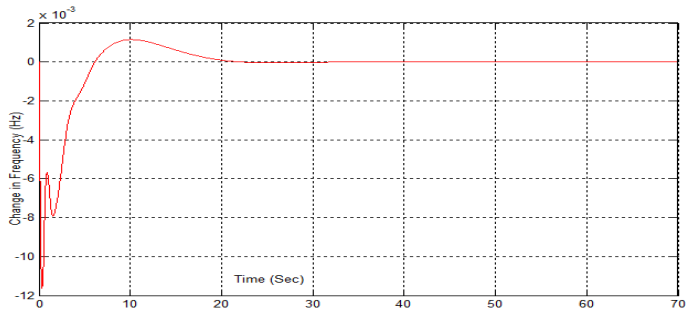

Figure 15. Frequency Response of Area 2 with GA Controller

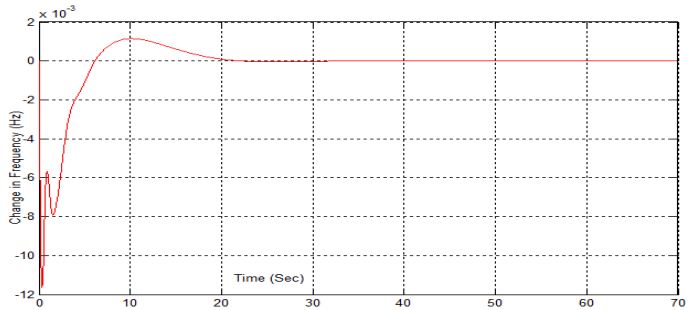

Figure 16. Frequency Response of Area 3 with GA Controller

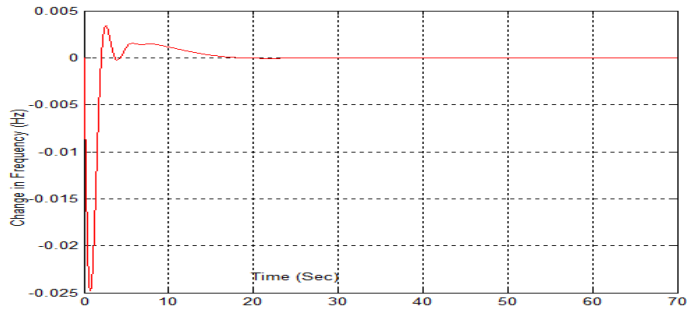

Figure 17. Frequency Response of Area 4 with GA Controller

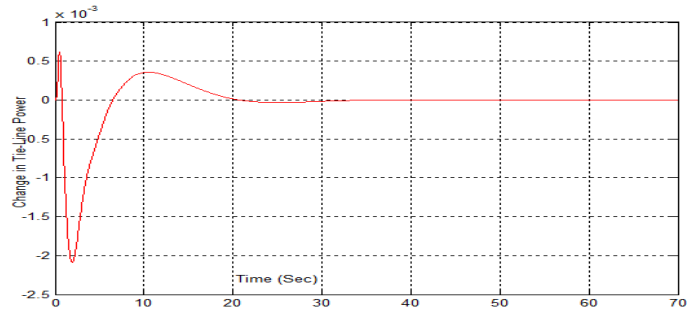

Figure 18. Tie-Line Power Response of Area 1 with GA Controller

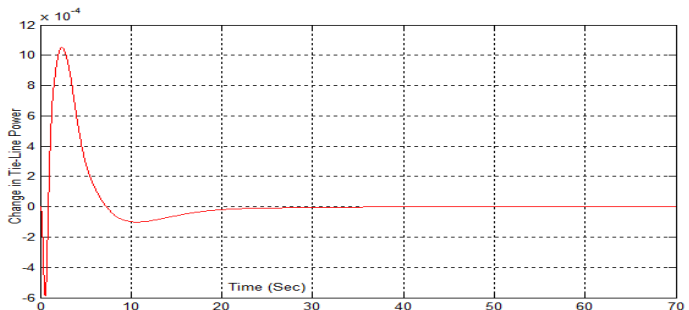

Figure 19. Tie-Line Power Response of Area 2 with GA Controller

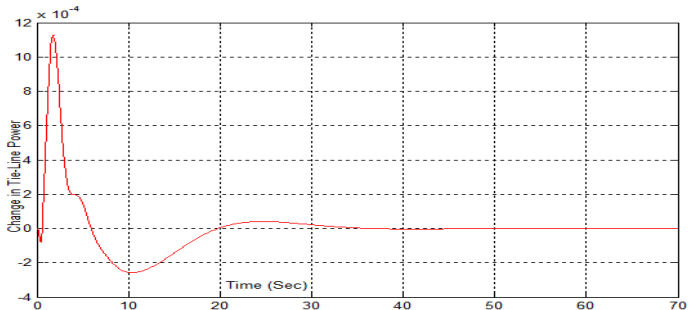

Figure 20. Tie-Line Power Response of Area 3 with GA Controller

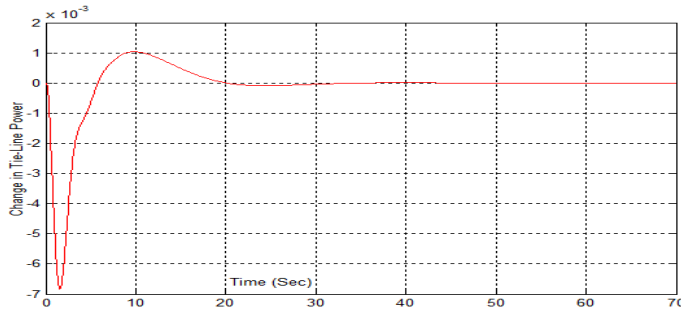

Figure 21. Tie-Line Power Response of Area 4 with GA Controller

Table 4. Comparative value of settling time (Proposed)

Controller	Settling Time (Sec)							
	Frequency Deviation				Tie-Line Power Deviation			
	Area 1	Area 2	Area 3	Area 4	Area 1	Area 2	Area 3	Area 4
Fuzzy	24	24	25	20	35	36	38	33
GA	20	21	21	17	32	33	35	32

5. Conclusions

The performance of automatic generation control of four area reheat thermal power system is investigated in this paper. To demonstrate the effectiveness of proposed controller evolutionary (Genetic Algorithm for tuning of PID controller) technique, the control strategy based on intelligent (Fuzzy Logic) technique is applied. The performance of these techniques is evaluated through the simulation. The results are tabulated in Table II respectively.

The results of proposed technique have been compared with conventional and intelligent technique and it shows that the proposed technique give good dynamic performances and results. So it can be concluded that the evolutionary technique give better settling performance than the intelligent controllers.

Appendix

Power System Parameters are as follows:

$f=60\text{Hz}$; $R_1=R_2=R_3=R_4=2.4\text{Hz/p.uMW}$; $T_{sg1}=T_{sg2}=T_{sg3}=T_{sg4}=0.08\text{Sec}$; $T_{ps1}=T_{ps2}=T_{ps3}=T_{ps4}=20\text{Sec}$;
 $T_{t1}=T_{t2}=T_{t3}=T_{t4}=0.3\text{Sec}$; $T_{r1}=T_{r2}=T_{r3}=T_{r4}=10\text{Sec}$; $K_{r1}=K_{r2}=0.5\text{TU}$; $K_{r3}=3.33\text{TU}$; $K_{r4}=3\text{TU}$;
 $a_{12}=a_{23}=a_{34}=a_{41}=1$; $H_1=H_2=H_3=H_4=5\text{MW-S/MVA}$; $P_{r1}=P_{r2}=P_{r3}=P_{r4}=2000\text{MW}$;
 $K_{ps1}=K_{ps2}=K_{ps3}=K_{ps4}=120\text{Hz /puMW}$; $K_{sg1}=K_{sg2}=K_{sg3}=K_{sg4}=1$; $K_{t1}=K_{t2}=K_{t3}=K_{t4}=1$; $D_{1234}=8.33*10^{-3}\text{p.uMW/Hz}$;
 $B_{1234}=0.425\text{p.u.MW/hz}$; $\Delta P_{D1234}=0.01\text{ p.u.}$; $T_{12}=T_{23}=T_{34}=T_{41}=0.0867\text{MW/Radian}$; $P_{tie\text{max}}=200\text{MW}$.

Nomenclature

AGC Automatic Generation Control
 P_{ri} Rated power capacity of area i
 f Nominal system frequency
 Δf Change in supply frequency
 D_i System damping area i
 T_{sg} Speed governor time constant
 T_t Steam turbine time constant
 T_{ps} Power system time constant

K_{sg}	Speed governor gain constant
K_t	Steam turbine gain constant
K_{ps}	Power system gain constant
B_i	Frequency bias parameter
ΔP_{Di}	Incremental load change in area i
i	Subscript referring to area 1 2 3 etc.
H	Inertia constant
R	Speed regulation of governor
a	Ratio of rated power of a pair of areas four area system
T	Synchronous coefficient of tie-line system
$P_{tie,max}$	Tie-line power

6. Acknowledgement

This work is supported by electrical engineering department, Sam Higginbottom Institute of Agriculture Technology and Sciences. Allahabad, India.

7. References

- [1] Magla, J. Nanda, "Automatic Generation Control of an Interconnected Hydro-Thermal System Using Conventional Integral and Fuzzy logic Control", in Proc. *IEEE Electric Utility Deregulation, Restructuring and Power Technologies*, Apr 2004.
- [2] P. Kothari, Nagrath "Modern Power System Analysis"; Tata McGraw Hill, Third Edition, 2003.
- [3] Elgerd O. I, "Electric Energy System Theory; An Introduction" McGraw Hill, 1971.
- [4] Surya Prakash, S K Sinha, "Four Area Load Frequency Control of Interconnected Hydro-Thermal Power System by Intelligent PID Control Technique"; 978-1-4673-0455-9/12, IEEE 2012.
- [5] K.P.Singh Parmar, S.Majhi, D.P.Kothari, "Optimal Load Frequency Control of an Interconnected Power System"; *MIT International Journal of Electrical and Instrumentation Engineering* Vol. 1, No. 1, Jan.2011, pp. 1-5, ISSS No. 2230-7656, MIT Publications.
- [6] Surya Prakash, S K Sinha, "Intelligent PI Control Technique in Four Area Load Frequency Control of Interconnected Hydro-thermal Power System"; 978-1-4673-0210-4/12, IEEE 2012.
- [7] Rishabh Verma, Shalini Pal, Sathans, "Intelligent Automatic Generation Control of Two-Area Hydrothermal Power System using ANN and Fuzzy Logic"; 978-0-7695-4958-3/13, IEEE 2013.
- [8] Kiran Kumar Challa, P.S.Nagendra Rao, "Analysis and Design of Controller for Two Area Thermal-Hydro-Gas AGC System"; 978-1-4244-7781-4/10, IEEE 2010.
- [9] S. Sivanagaraju, G. Sreenivasan, "Power System Operation and Control". PEARSON (2011).
- [10] S.Hasan Saeed, "Automatic Control System", 2006.
- [11] Hadi Sadat, "Power System Analysis". Tata MCGraw Hill 1999.
- [12] Ranjit Roy, S. P. Ghoshal, Praghness Bhatt, "Evolutionary Computation based Four-Area Automatic Generator Control in Restructured Environment"; 978-1-4244-4331-4/09, IEEE 2009.
- [13] Xiangjie Liu, Xiaolei Zhan, Dianwei Quian, "Load Frequency Control considering Generation Rate Constraints"; 978-1-4244-6712-9/10, IEEE 2010.
- [14] Sapna Bhati, Dhiiraj Nitnawre, "Genetic Optimization Tuning of an Automatic Voltage Regulator System"; *IJSET*, Volume No.1, Issue No. 3, pg: 120-124, ISSN: 2277-1581, 01July 2012.
- [15] K. F.Man, K. S.Tang and S. Kwong, "Genetic algorithm: Concepts and applications"; *IEEE Trans. Ind. Electron*, vol. 43, no. 5, pp. 519-534, may 1996.

- [16] Naresh Kumari, A. N. Jha, "Automatic Generation Control Using LQR based PI Controller for Multi Area interconnected Power System"; *Advance in Electronic and Electric Engineering*, ISSN 2231-1297, Volume 4, pp. 149-154, November 2, 2014.
- [17] S. Prakash, S.K. Sinha, "Neuro-Fuzzy Computational Technique to Control Load Frequency in Hydro-Thermal Interconnected Power System"; *J, Inst, Eng, India Ser, B*, DOI 10.1007/s40031-014-0147-3, ISSN 2250-2106, Published by Springer 2014
- [18] Surya Prakash, SK Sinha, Load Frequency Control of Multi-Area power System Using Neuro Fuzzy Hybrid Intelligent Controllers, *IETE Journal of Research*: DOI: 10.1080/03772063.2015.1024765, Taylor & Francis, Apr- 2015.



Ashish Dhamanda Haridwar's specialization are in Power System and Automatic Generation Control and Currently working as a faculty in Faculty of Engineering and Technology, Gurukula Kangri University Haridwar, Uttarakhand, India. dhamanda_ashish@yahoo.co.in



Arunesh Dutt Dehradun, Presently he is working as an Assistant Professor and Head in Electrical and Electronics Engineering Department, Sanjay Gandhi Institute of Engineering and Technology, Nehru Gram Bharati University, Allahabad, India. aru_121@rediffmail.com



A. K. Bhardwaj Allahabad, Presently he is working as an Associate Professor and HOD in Electrical Engineering Department. Shepherd School of Engineering and Technology, Sam Higginbottom Institute of Agriculture Technology and Sciences Deemed University Allahabad India. dr.akbhardwaj65@rediff.com